































Assemble screws		
Part	Sizes in mm	Pcs
	8 x 90	4
	8 x 80	12
	8 x 75	4
	8 x 55	4
	8 x 50	2
	6 x 90	14
	5 x 50	48
	4 x 50	4
	4 x 30	8
	M 14	4
	M12	8
	M 6	14
	M 8	26
	M 6	14
	M 8	26
	M 12	8
	Plastics	32
		

Parts		Pcs
	Back part	2
	Seat	2
	Floor	1
	Leg part	4
	Cross board	4
	Swing holder	4
	Arm rest	4
	Top board	2
	Top support cm	4
	Low support cm	4
	Long top support	4
	Long low support	2
	Top bar 1370 mm	2
	Casing for top bar 1070	2
	Low bar 1260mm	2
	Casing for low bar 1015	2
	Table	1
	Support for table, long	1
	Support parts under table	2

# Suomi-swing

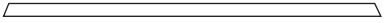
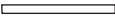
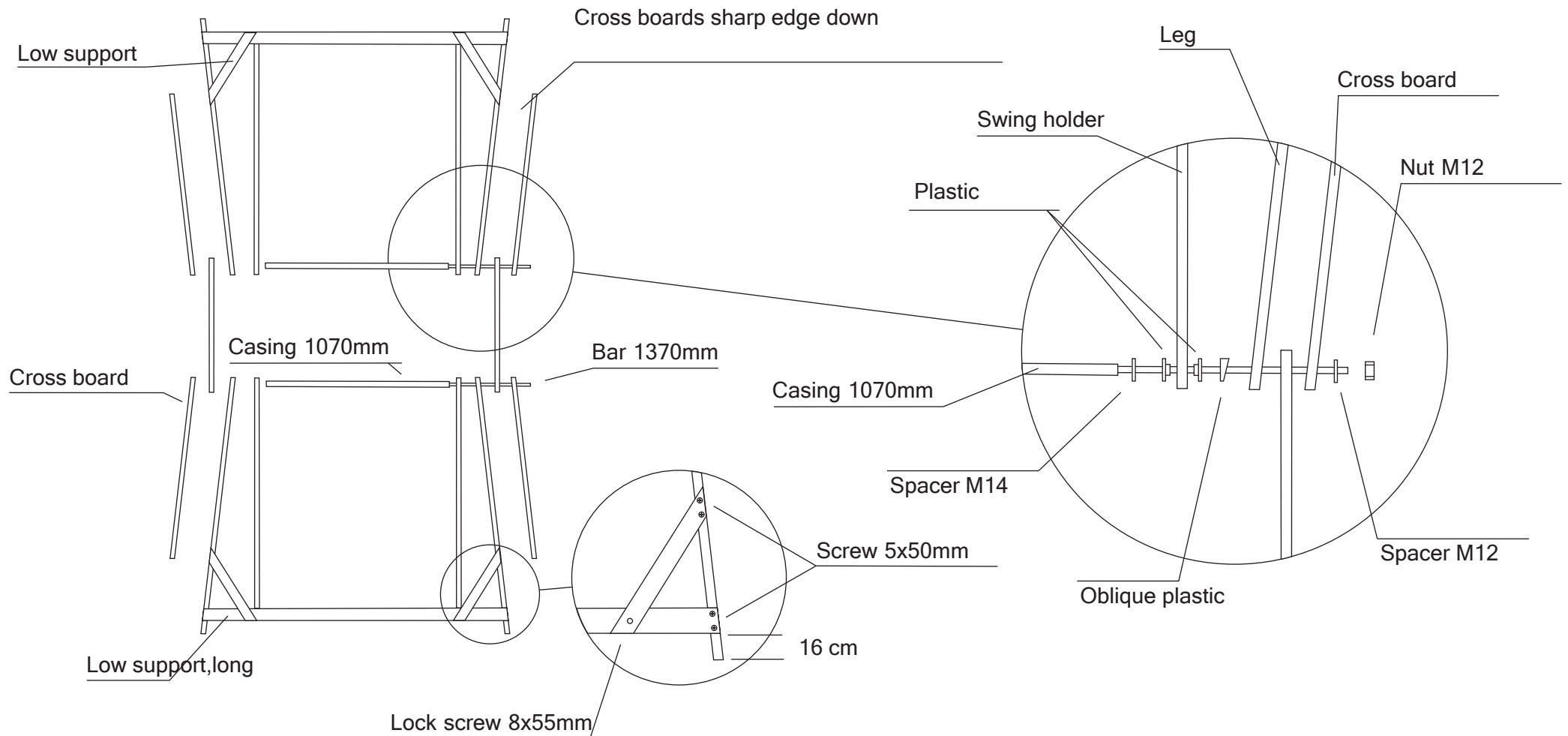

-This swing must be installed on level ground.  
 -Photo is taken from above.  
 -Attach long support board about 16 cm from the bottom, low support sharp edge up.

-Attach low supports laxly.  
 -Attach both bars and parts which are needed according to the picture.  
 -It is recommended that two or more person assemble this swing.

# Suomi-swing

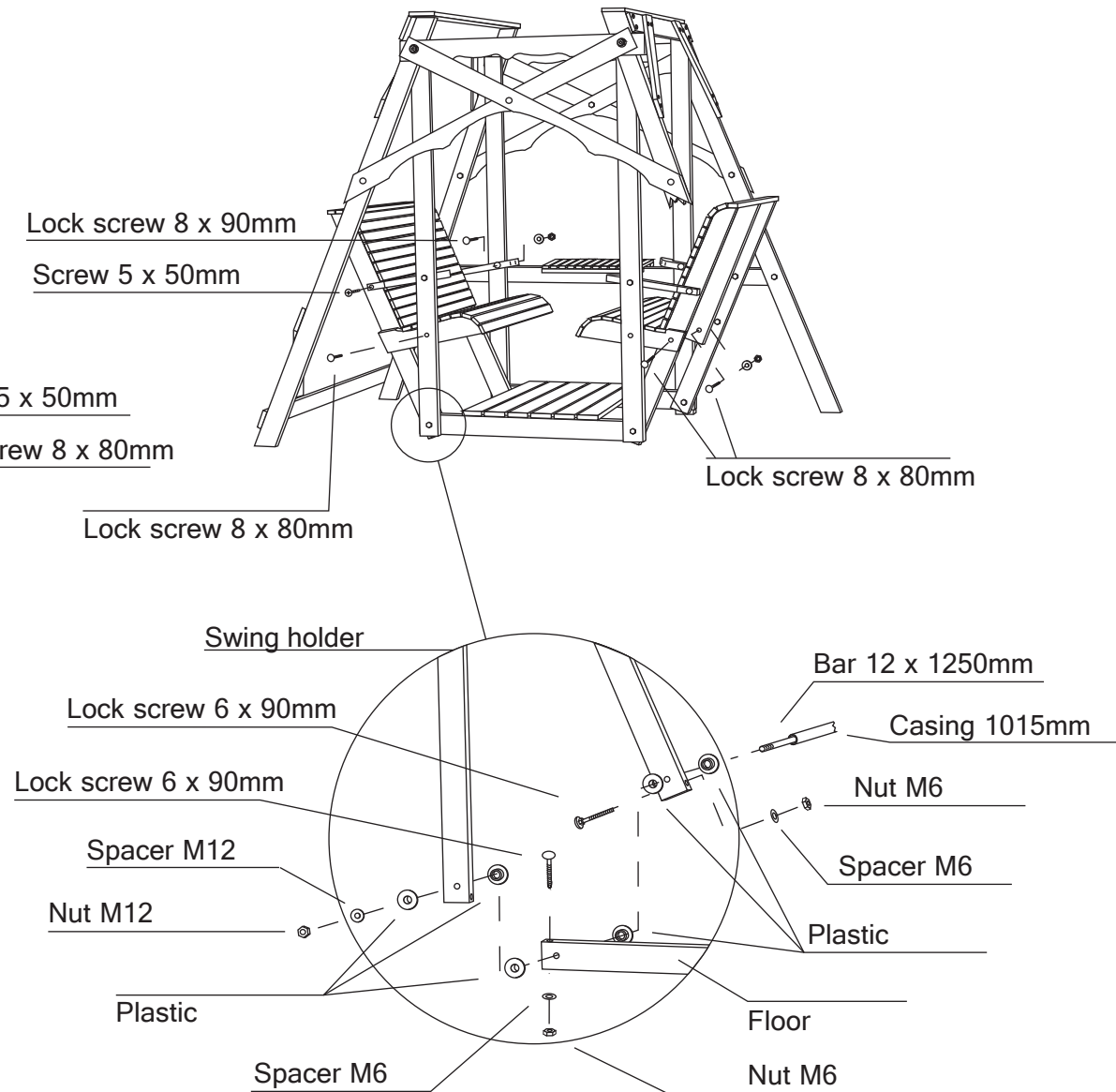
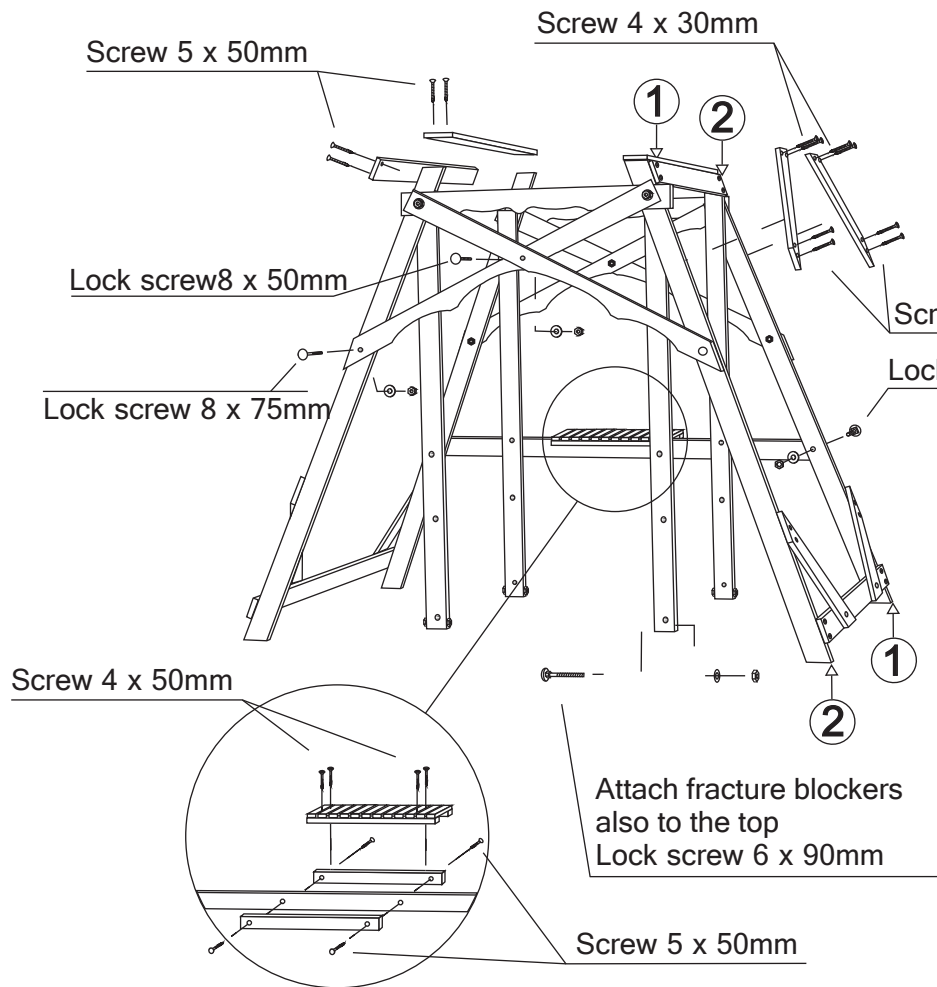

- Raise the swing up and attach cross boards
- Attach long top support boards, so bars are in straight level.
- Measurement between dots 1-1 and 2-2 should be same before tightening low and top supports.

-2-

- Treat the swing with wood oil.
- Tighten all nuts, bolts after two weeks.
- Pine wood contains resin.